

Svetlosť Ø		RA	Závit D6-H	d Ø	SW	
mm	inch	mm		mm	mm	
6	1/4"	6	M12x1,5	4	17	DKL M12x1,5
		8	M14x1,5	4	17	DKL
		12	M18x1,5	4	22	DKL M18x1,5
8	5/16"	10	M16x1,5	5,7	19	DKL
		12	M18x1,5	5,7	22	DKL M18x1,5
10	3/8"	12	M20x1,5	7	24	DKL M20x1,5
		12	M18x1,5	7	22	DKL
12	1/2"	12	M20x1,5	9,5	24	DKL M20x1,5
		15	M22x1,5	9,5	27	DKL RA15 M22x1,5
		16	M24x1,5	9,5	30	DKL M24x1,5
		16	M22x1,5	9,5	27	DKL
16	5/8"	18	M26x1,5	12	32	DKL M26x1,5
		18	M27x1,5	12	32	DKL
		18	M27x2	12	32	DKL M27x2
20	3/4"	22	M30x2	15	36	DKL
		22	M30x1,5	15	36	DKL M30x1,5
25	1"	28	M36x2	20	41	DKL
		28	M38x1,5	20	46	DKL M38x1,5
		28	M39x1,5	20	46	DKL M39x1,5
32	1 1/4"	35	M45x2	26	50	DKL
		35	M45x1,5	26	50	DKL M45x1,5

DKL

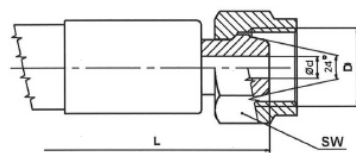

Svetlosť Ø		RA	Závit D6-H	d Ø	SW	l	
mm	inch	mm		mm	mm	mm	
6	1/4"	6	M12x1,5	4	17	17	DKL45° M12x1,5
		8	M14x1,5	4	17	17	DKL45°
8	5/16"	10	M16x1,5	5,7	19	19	DKL45°
10	3/8"	12	M18x1,5	7	22	22	DKL45°
		12	M20x1,5	7	24	22	DKL45° M20x1,5
12	1/2"	12	M20x1,5	9,5	24	24	DKL45° M20x1,5
		15	M22x1,5	9,5	27	24	DKL45°RA15 M22x1,5
		16	M24x1,5	9,5	30	24	DKL45° M24x1,5
		16	M22x1,5	9,5	27	24	DKL45°
16	5/8"	18	M26x1,5	12	32	29	DKL45° M26x1,5
		18	M27x1,5	12	32	29	DKL45°
		18	M27x2	12	32	29	DKL45° M27x2
20	3/4"	22	M30x2	15	36	36	DKL45°
		22	M30x1,5	15	36	36	DKL45° M30x1,5
25	1"	28	M36x2	20	41	43	DKL45°
		28	M38x1,5	20	46	43	DKL45° M38x1,5
		28	M39x1,5	20	46	43	DKL45° M39x1,5
32	1 1/4"	35	M45x2	26	50	60	DKL45°
		35	M45x1,5	26	50	60	DKL45° M45x1,5

DKL 45°

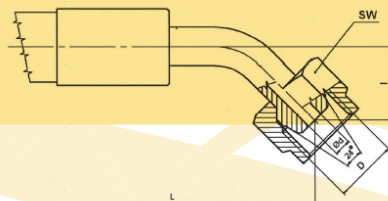

Všetky ďalšie typy, druhy a rozmery hydraulických konoviek držíme skladom celoročne k okamžitému predaju, v prípade špecifikácie kontaktujte našu firmu.

DKL 90°

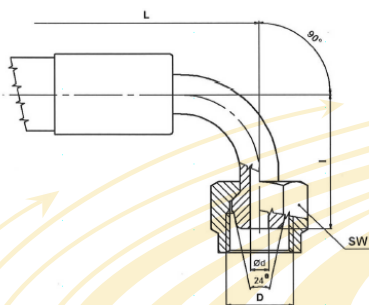

Svetlost' Ø		RA	Závit D6-H	d Ø	SW	l	
mm	inch	mm		mm	mm	mm	
6	1/4"	6	M12x1,5	4	17	27	DKL90° M12x1,5
		8	M14x1,5	4	17	27	DKL90°
8	5/16"	10	M16x1,5	5,7	19	30	DKL90°
10	3/8"	12	M18x1,5	7	22	34	DKL90°
		12	M20x1,5	7	24	34	DKL90° M20x1,5
12	1/2"	12	M20x1,5	9,5	24	37	DKL90° M20x1,5
		15	M22x1,5	9,5	27	37	DKL90°RA15 M22x1,5
		16	M24x1,5	9,5	30	37	DKL90° M24x1,5
		16	M22x1,5	9,5	27	37	DKL90°
16	5/8"	18	M26x1,5	12	32	44	DKL90° M26x1,5
		18	M27x1,5	12	32	44	DKL90°
		18	M27x2	12	32	44	DKL90° M27x2
20	3/4"	22	M30x2	15	36	54	DKL90°
		22	M30x1,5	15	36	54	DKL90° M30x1,5
25	1"	28	M36x2	20	41	64	DKL90°
		28	M38x1,5	20	46	64	DKL90° M38x1,5
		28	M39x1,5	20	46	64	DKL90° M39x1,5
32	1 1/4"	35	M45x2	26	50	80	DKL90°
		35	M45x1,5	26	50	60	DKL90° M45x1,5

CEL

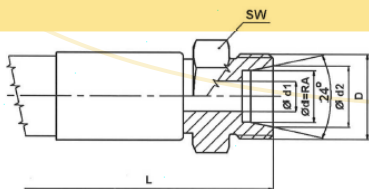

Svetlost' Ø		RA	Závit D6-H	d1 Ø	d2 Ø	d3 Ø	
mm	inch	mm		mm	mm	mm	
6	1/4"	6	M12x1,5	4	8,1	17	CEL M12x1,5
		8	M14x1,5	4	10,1	17	CEL
8	5/16"	10	M16x1,5	5,7	12,3	19	CEL
10	3/8"	12	M18x1,5	7	14,3	22	CEL
		12	M20x1,5	7	14,3	24	CEL M20x1,5
12	1/2"	12	M20x1,5	9,5	14,3	24	CEL M20x1,5
		15	M22x1,5	9,5	17,3	27	CEL
		16	M24x1,5	9,5	18,3	30	CEL RA16 M24x1,5
		16	M22x1,5	9,5	18,3	27	CEL RA16 M22x1,5
16	5/8"	18	M26x1,5	12	20,3	32	CEL M26x1,5
		18	M27x1,5	12	20,3	32	CEL
		18	M27x2	12	20,3	32	CEL M27x2
20	3/4"	22	M30x2	15	24,3	36	CEL
		22	M30x1,5	15	24,3	36	CEL M30x1,5
25	1"	28	M36x2	20	30,3	41	CEL
32	1 1/4"	35	M45x2	26	38	50	CEL
		35	M45x1,5	26	38	50	CEL M45x1,5

Všetky ďalšie typy, druhy a rozmery hydraulických koncoviek držíme skladom celoročne k okamžitému predaju, v prípade špecifikácie kontaktujte našu firmu.

Svetlosť Ø		RA	Závit D6-H	d Ø	SW	
mm	inch	mm		mm	mm	
6	1/4"	8	M14x1,5	4	17	DKOL
8	5/16"	10	M16x1,5	5,7	19	DKOL
10	3/8"	12	M18x1,5	7	22	DKOL
12	1/2"	15	M22x1,5	9,5	27	DKOL
		16	M24x1,5	9,5	30	DKOL M24x1,5
		16	M22x1,5	9,5	27	DKOL RA16 M22x1,5
16	5/8"	18	M26x1,5	12	32	DKOL
		18	M27x1,5	12	32	DKOL M27x1,5
		18	M27x2	12	32	DKOL M27x2
20	3/4"	22	M30x2	15	36	DKOL
		22	M30x1,5	15	36	DKOL M30x1,5
25	1"	28	M36x2	20	41	DKOL
		28	M39x1,5	20	46	DKOL M39x1,5
32	1 1/4"	35	M45x2	26	50	DKOL
		35	M45x1,5	26	50	DKOL M45x1,5

DKOL

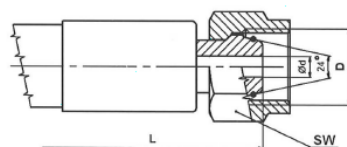

Svetlosť Ø		RA	Závit D6-H	d Ø	SW	l	
mm	inch	mm		mm	mm	mm	
6	1/4"	8	M14x1,5	4	17	14	DKOL45°
8	5/16"	10	M16x1,5	5,7	19	15	DKOL45°
10	3/8"	12	M18x1,5	7	22	18	DKOL45°
12	1/2"	15	M22x1,5	9,5	27	19	DKOL45°
		16	M24x1,5	9,5	30	19	DKOL45° M24x1,5
		16	M22x1,5	9,5	27	19	DKOL45° RA16 M22x1,5
16	5/8"	18	M26x1,5	12	32	23	DKOL45°
		18	M27x1,5	12	32	23	DKOL45° M27x1,5
		18	M27x2	12	32	23	DKOL45° M27x2
20	3/4"	22	M30x2	15	36	25	DKOL45°
		22	M30x1,5	15	36	25	DKOL45° M30x1,5
25	1"	28	M36x2	20	41	32	DKOL45°
		28	M39x1,5	20	46	32	DKOL45° M39x1,5
32	1 1/4"	35	M45x2	26	50	60	DKOL45°
		35	M45x1,5	26	50	60	DKOL45° M45x1,5

DKOL 45°

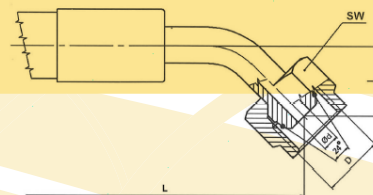

Všetky ďalšie typy, druhy a rozmery hydraulických koncoviek držíme skladom celoročne k okamžitému predaju, v prípade špecifikácie kontaktujte našu firmu.

DKOL 90°

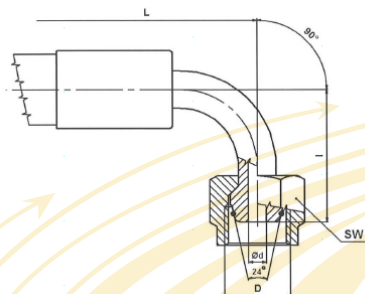

Svetlost'Ø		RA	Závit D6-H	d Ø	SW	l	
mm	inch	mm		mm	mm	mm	
6	1/4"	8	M14x1,5	4	17	30	DKOL90°
8	5/16"	10	M16x1,5	5,7	19	33	DKOL90°
10	3/8"	12	M18x1,5	7	22	36	DKOL90°
12	1/2"	15	M22x1,5	9,5	27	40	DKOL90°
		16	M24x1,5	9,5	30	40	DKOL90° M24x1,5
		16	M22x1,5	9,5	27	40	DKOL90° RA16 M22x1,5
16	5/8"	18	M26x1,5	12	32	51	DKL90°
		18	M27x1,5	12	32	51	DKOL90° M27x1,5
		18	M27x2	12	32	51	DKOL90° M27x2
20	3/4"	22	M30x2	15	36	56	DKOL90°
		22	M30x1,5	15	36	56	DKOL90° M30x1,5
25	1"	28	M36x2	20	41	68	DKOL90°
		28	M39x1,5	20	46	68	DKOL90° M39x1,5
32	1 1/4"	35	M45x2	26	50	80	DKOL90°
		35	M45x1,5	26	50	80	DKOL90° M45x1,5

CES

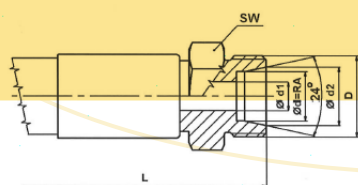

Svetlost'Ø		RA	Závit D6-H	d1 Ø	d2 Ø	SW	
mm	inch	mm		mm	mm	mm	
6	1/4"	10	M18x1,5	4	12,3	19	CES
8	5/16"	12	M20x1,5	5,7	14,3	22	CES
10	3/8"	14	M22x1,5	7	16,3	24	CES
12	1/2"	16	M24x1,5	9,5	18,3	27	CES
16	5/8"	20	M30x1,5	12	22,9	32	CES
20	3/4"	25	M36x2	15	27,9	41	CES
25	1"	30	M42x2	20	33	46	CES
32	1 1/4"	38	M52x2	26	41	55	CES

DKOS

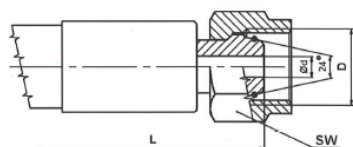

Svetlost'Ø		RA	Závit D6-H	d Ø	SW	
mm	inch	mm		mm	mm	
6	1/4"	10	M18x1,5	4	22	DKOS
8	5/16"	12	M20x1,5	5,7	24	DKOS
10	3/8"	14	M22x1,5	7	27	DKOS
12	1/2"	16	M24x1,5	9,5	30	DKOS
16	5/8"	20	M30x1,5	12	36	DKOS
20	3/4"	25	M36x2	15	46	DKOS
25	1"	30	M42x2	20	50	DKOS
32	1 1/4"	38	M52x2	26	60	DKOS

Všetky ďalšie typy, druhy a rozmery hydraulických koncoviek držíme skladom celoročne k okamžitému predaju, v prípade špecifikácie kontaktujte našu firmu.

Svetlosť Ø		RA	Závit D6-H	d Ø	SW	l	
mm	inch	mm		mm	mm	mm	
6	1/4"	10	M18x1,5	4	22	18	DKOS45°
8	5/16"	12	M20x1,5	5,7	24	20	DKOS45°
10	3/8"	14	M22x1,5	7	27	22	DKOS45°
12	1/2"	16	M24x1,5	9,5	30	25	DKOS45°
16	5/8"	20	M30x1,5	12	36	23	DKOS45°
20	3/4"	25	M36x2	15	46	30	DKOS45°
25	1"	30	M42x2	20	50	35	DKOS45°
32	1 1/4"	38	M52x2	26	60	65	DKOS45°

DKOS 45°

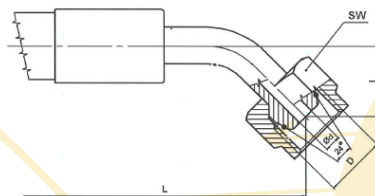

Svetlosť Ø		RA	Závit D6-H	d Ø	SW	l	
mm	inch	mm		mm	mm	mm	
6	1/4"	10	M18x1,5	4	22	32	DKOS90°
8	5/16"	12	M20x1,5	5,7	24	34	DKOS90°
10	3/8"	14	M22x1,5	7	27	38	DKOS90°
12	1/2"	16	M24x1,5	9,5	30	43	DKOS90°
16	5/8"	20	M30x1,5	12	36	49	DKOS90°
20	3/4"	25	M36x2	15	46	59	DKOS90°
25	1"	30	M42x2	20	50	70	DKOS90°
32	1 1/4"	38	M52x2	26	60	90	DKOS90°

DKOS 90°

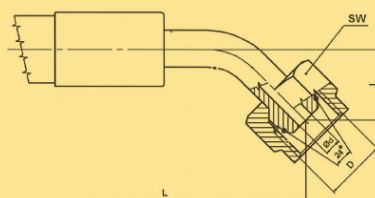

Svetlosť Ø		Ø d-H11	Ø B-h11	d1 Ø	D Ø
mm	inch	mm		mm	mm
6	1/4"	12	12	4	20
8	5/16"	14	14	5,7	24
10	3/8"	16	16	7	28
12	1/2"	18	20	9,6	32
16	5/8"	22	25	12	40

RN-BANJO

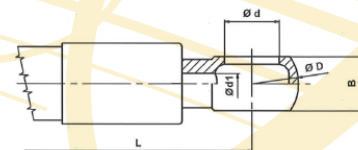

Všetky ďalšie typy, druhy a rozmery hydraulických koncoviek držíme skladom celoročne k okamžitému predaju, v prípade špecifikácie kontaktujte našu firmu.

DKR

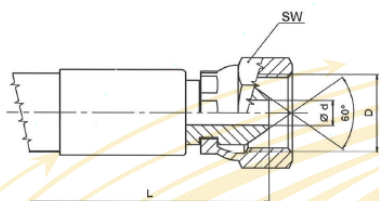

Svetlost' Ø		d Ø	Závit	SW	
mm	inch	mm		mm	
6	1/4"	4	1/4-19"	19	DKR
8	5/16"	5,7	3/8-19"	22	DKR
10	3/8"	7	3/8-19"	22	DKR
12	1/2"	9,5	1/2-14"	27	DKR
16	5/8"	12	5/8-14"	30	DKR
20	3/4"	15	3/4-14"	32	DKR
25	1"	20	1"-11	38	DKR
32	1 1/4"	26	1 1/4"-11	50	DKR

DKR 45°

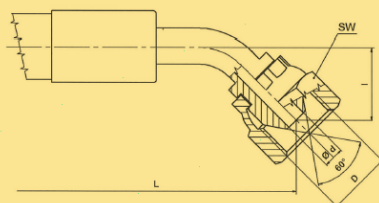

Svetlost' Ø		d Ø	Závit	SW	l	
mm	inch	mm		mm	mm	
6	1/4"	4	1/4-19"	19	17	DKR45°
8	5/16"	5,7	3/8-19"	22	19	DKR45°
10	3/8"	7	3/8-19"	22	22	DKR45°
12	1/2"	9,5	1/2-14"	27	24	DKR45°
16	5/8"	12	5/8-14"	30	29	DKR45°
20	3/4"	15	3/4-14"	32	36	DKR45°
25	1"	20	1"-11	38	43	DKR45°
32	1 1/4"	26	1 1/4"-11	50	60	DKR45°

DKR 90°

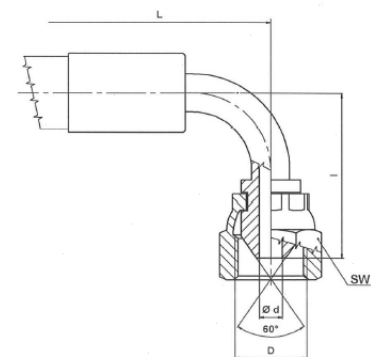

Svetlost' Ø		d Ø	Závit	SW	l	
mm	inch	mm		mm	mm	
6	1/4"	4	1/4-19"	19	27	DKR90°
8	5/16"	5,7	3/8-19"	22	30	DKR90°
10	3/8"	7	3/8-19"	22	34	DKR90°
12	1/2"	9,5	1/2-14"	27	37	DKR90°
16	5/8"	12	5/8-14"	30	44	DKR90°
20	3/4"	15	3/4-14"	32	54	DKR90°
25	1"	20	1"-11	38	64	DKR90°
32	1 1/4"	26	1 1/4"-11	50	80	DKR90°

Všetky ďalšie typy, druhy a rozmery hydraulických koncoviek držíme skladom celoročne k okamžitému predaju, v prípade špecifikácie kontaktujte našu firmu.

Svetlosť Ø		d Ø	Závit	SW		
mm	inch	mm		mm		
6	1/4"	4	1/4-19"	19	AGR	DKR45°
8	5/16"	5,7	3/8-19"	22	AGR	DKR45
10	3/8"	7	3/8-19"	22	AGR	DKR45°
12	1/2"	9,5	1/2-14"	27	AGR	DKR45°
16	5/8"	12	5/8-14"	30	AGR	DKR45°
20	3/4"	15	3/4-14"	32	AGR	DKR45°
25	1"	20	1"-11	38	AGR	DKR45°
32	1 1/4"	26	1 1/4"-11	50	AGR	DKR45°

AGR

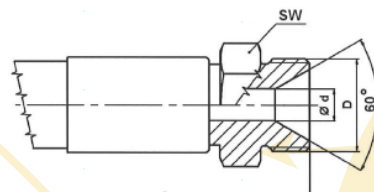

Svetlosť Ø		d Ø	d1 Ø	D Ø	B	O - krúžok	
mm	inch	mm	mm	mm	mm	mm	
12	1/2"	9,5	24	30,2	6,7	18,64x3,53	SFL
16	5/8"	12	24	38,1	6,7	24,99x3,53	SFL
20	3/4"	15	32	38,1	6,7	24,99x3,53	SFL
25	1"	20	38	44,5	8	32,92x3,53	SFL
32	1 1/4"	26	43,5	50,8	8	37,69x3,53	SFL

SFL

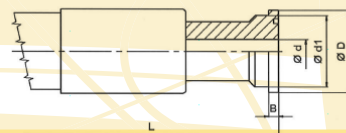

Svetlosť Ø		d Ø	d1 Ø	D Ø	B	l	O - krúžok	
mm	inch	mm	mm	mm	mm	mm	mm	
12	1/2"	9,5	24	30,2	6,7	40	18,64x3,53	SFL45°
16	5/8"	12	24	38,1	6,7	45	24,99x3,53	SFL45°
20	3/4"	15	32	38,1	6,7	50	24,99x3,53	SFL45°
25	1"	20	38	44,5	8	55	32,92x3,53	SFL45°
32	1 1/4"	26	43,5	50,8	8	60	37,69x3,53	SFL45°

SFL 45°

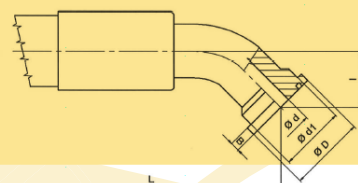

Svetlosť Ø		d Ø	d1 Ø	D Ø	B	l	O - krúžok	
mm	inch	mm	mm	mm	mm	mm	mm	
12	1/2"	9,5	24	30,2	6,7	40	18,64x3,53	SFL90°
16	5/8"	12	24	38,1	6,7	45	24,99x3,53	SFL90°
20	3/4"	15	32	38,1	6,7	50	24,99x3,53	SFL90°
25	1"	20	38	44,5	8	60	32,92x3,53	SFL90°
32	1 1/4"	26	43,5	50,8	8	80	37,69x3,53	SFL90°

SFL 90°

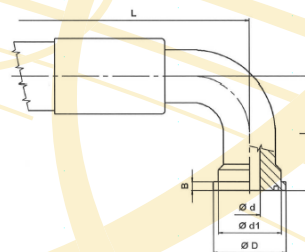

Všetky ďalšie typy, druhy a rozmery hydraulických koncoviek držíme skladom celoročne k okamžitému predaju, v prípade špecifikácie kontaktujte našu firmu.

SFS

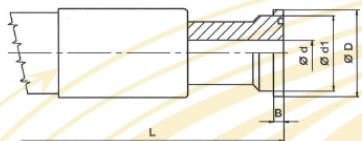

Svetlost' Ø		d Ø	d1 Ø	D Ø	B	O - hrúžok	
mm	inch	mm	mm	mm	mm	mm	
12	1/2"	9,5	24	31,7	7,8	18,64x3,53	SFS
16	5/8"	12	24	31,7	7,8	24,99x3,53	SFS
20	3/4"	15	32	41,3	8,8	24,99x3,53	SFS
25	1"	20	38	47,6	9,5	32,92x3,53	SFS
32	1 1/4"	26	44	54	10,3	37,69x3,53	SFS

STECK

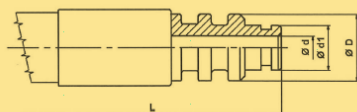

Svetlost' Ø		d Ø	d1 - e8 Ø	D - D9 Ø	O - hrúžok	
mm	inch	mm	mm	mm	mm	
6	1/4"	4	10	15	6x2	STECKO
8	5/16"	5,7	14	20	10x2	STECKO
10	3/8"	7	14	20	10x2	STECKO
12	1/2"	9,5	18	24	13x2,5	STECKO
16	5/8"	12	21	26	16x2,5	STECKO
20	3/4"	15	24	29	19x2,5	STECKO
25	1"	20	31	39	25x2,5	STECKO
32	1 1/4"	26	38	46	33x2,5	STECKO

Všetky ďalšie typy, druhy a rozmery hydraulických koncoviek držíme skladom celoročne k okamžitému predaju, v prípade špecifikácie kontaktujte našu firmu.